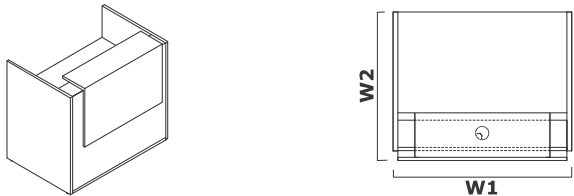
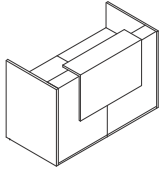
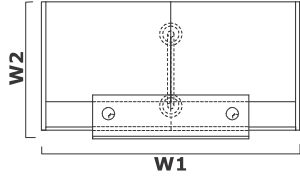
								
Symbol	Cena netto PLN	Wymiary					Waga Obj. Opak.	Elementy składowe
		W1	W2	D1	D2	H		
TRA13	1455,-	856	820			1090	65.3 kg 0.124 m3 3 szt.	TR1L+TR08+TR1P

Dodatkowa dopłata						

								
Symbol	Cena netto PLN	Wymiary					Waga Obj. Opak.	Elementy składowe
		W1	W2	D1	D2	H		
TRA14	3125,-	1056	877			1159	86.5 kg 0.32 m3 4 szt.	TR1L+TR10+TR99+TR1P
TRA15	3200,-	1256	877			1159	94.7 kg 0.332 m3 4 szt.	TR1L+TR12+TR99+TR1P
TRA16	3270,-	1456	877			1159	103.15 kg 0.344 m3 4 szt.	TR1L+TR14+TR99+TR1P

Dodatkowa dopłata						

 								
Symbol	Cena netto PLN	Wymiary					Waga Obj. Opak.	Elementy składowe
		W1	W2	D1	D2	H		
TRA17	4126,-	1656	877			1159	112.1 kg 0.425 m ³ 6 szt.	TR1L+2xTR08+TR99+TR1P+NL41
TRA18	4246,-	2056	877			1159	120.5 kg 0.449 m ³ 6 szt.	TR1L+2xTR10+TR99+TR1P+NL41
TRA19	4396,-	2456	877			1159	136.9 kg 0.473 m ³ 6 szt.	TR1L+2xTR12+TR99+TR1P+NL41
TRA20	4536,-	2856	877			1159	153.8 kg 0.498 m ³ 6 szt.	TR1L+2xTR14+TR99+TR1P+NL41

Dodatkowa dopłata					
Półka pod monitor x1	Półka pod monitor x 2				
376,-	752,-				
376,-	752,-				
376,-	752,-				

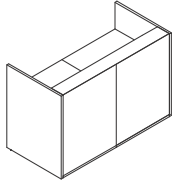
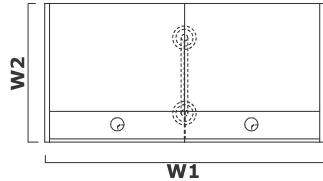
 								
Symbol	Cena netto PLN	Wymiary					Waga Obj. Opak.	Elementy składowe
		W1	W2	D1	D2	H		
TRA117	2516,-	1656	820			1090	95.1 kg 0.242 m ³ 5 szt.	TR1L+2xTR08+TR1P+NL41
TRA118	2636,-	2056	820			1090	103.5 kg 0.266 m ³ 5 szt.	TR1L+2xTR10+TR1P+NL41
TRA119	2786,-	2456	820			1090	119.9 kg 0.29 m ³ 5 szt.	TR1L+2xTR12+TR1P+NL41
TRA120	2926,-	2856	820			1090	136.8 kg 0.314 m ³ 5 szt.	TR1L+2xTR14+TR1P+NL41

Dodatkowa dopłata					
Półka pod monitor x1	Półka pod monitor x 2				
376,-	752,-				
376,-	752,-				
376,-	752,-				

Symbol	Cena netto PLN	Wymiary					Waga Obj. Opak.	Elementy składowe
		W1	W2	D1	D2	H		
TRA42	6440,-	1640	905			1159	123.35 kg 0.46 m3 8 szt.	TR4L+2xTR90+TR4P+TR99+NL41

Dodatkowa dopłata						

Symbol	Cena netto PLN	Wymiary					Waga Obj. Opak.	Elementy składowe
		W1	W2	D1	D2	H		
TRA21	7501,-	2440	905			1159	153.15 kg 0.577 m3 10 szt.	TR4L+2xTR90+TR08+TR4P+TR99+2xNL41
TRA22	7561,-	2640	905			1159	157.35 kg 0.59 m3 10 szt.	TR4L+2xTR90+TR10+TR4P+TR99+2xNL41
TRA23	7636,-	2840	905			1159	165.55 kg 0.602 m3 10 szt.	TR4L+2xTR90+TR12+TR4P+TR99+2xNL41
TRA24	7706,-	3040	905			1159	174 kg 0.614 m3 10 szt.	TR4L+2xTR90+TR14+TR4P+TR99+2xNL41

Dodatkowa dopłata						
Półka pod monitor x1						
	376,-					
	376,-					
	376,-					

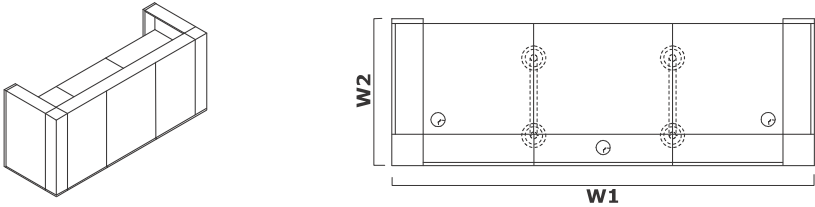

Symbol	Cena netto PLN	Wymiary					Waga Obj. Opak.	Elementy składowe
		W1	W2	D1	D2	H		
TRA121	5891,-	2440	848			1090	136.15 kg 0.394 m3 9 szt.	TR4L+2xTR90+TR08+TR4P +2xNL41
TRA122	5951,-	2640	848			1090	140.35 kg 0.406 m3 9 szt.	TR4L+2xTR90+TR10+TR4P +2xNL41
TRA123	6026,-	2840	848			1090	148.55 kg 0.418 m3 9 szt.	TR4L+2xTR90+TR12+TR4P +2xNL41
TRA124	6096,-	3040	848			1090	157 kg 0.43 m3 9 szt.	TR4L+2xTR90+TR14+TR4P +2xNL41

Dodatkowa dopłata						
Półka pod monitor x1						
	376,-					
	376,-					
	376,-					

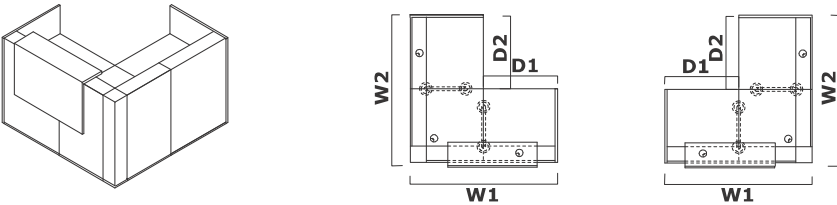

Symbol	Cena netto PLN	Wymiary					Waga Obj. Opak.	Elementy składowe
		W1	W2	D1	D2	H		
TRA25	6452,-	1648	1706			1159	161.35 kg 0.586 m3 9 szt.	TR1L+TR08+TR90+TR08+TR1P +TR99+2xNL41
TRA26	6512,-	1848	1648			1159	165.55 kg 0.598 m3 9 szt.	TR1L+TR08+TR90+TR10+TR1P +TR99+2xNL41
TRA27	6587,-	2048	1706			1159	173.75 kg 0.611 m3 9 szt.	TR1L+TR08+TR90+TR12+TR1P +TR99+2xNL41
TRA28	6657,-	2248	1648			1159	182.2 kg 0.623 m3 9 szt.	TR1L+TR08+TR90+TR14+TR1P +TR99+2xNL41

Dodatkowa dopłata						
Półka pod monitor x1						
	376,-					
	376,-					
	376,-					

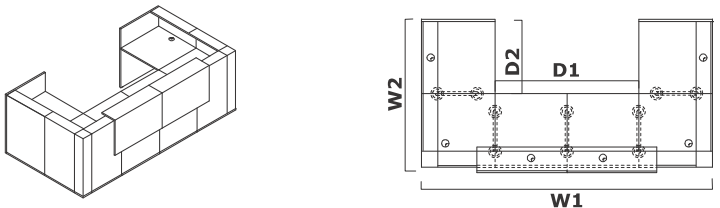

Symbol	Cena netto PLN	Wymiary					Waga Obj. Opak.	Elementy składowe
		W1	W2	D1	D2	H		
TRA29	12510,-	3240	1705			1159	287.2 kg 1.166 m ³ 17 szt.	TR1L+2xTR08+2xTR90+2xTR08 +TR1P+2xTR99+5xNL41
TRA30	12630,-	3640	1705			1159	295.6 kg 1.19 m ³ 17 szt.	TR1L+2xTR08+2xTR90+2xTR10+TR1P+2xTR99+5xNL41
TRA31	12780,-	4040	1705			1159	312 kg 1.214 m ³ 17 szt.	TR1L+2xTR08+2xTR90+2xTR12+TR1P+2xTR99+5xNL41
TRA32	12920,-	4440	1705			1159	328.9 kg 1.239 m ³ 17 szt.	TR1L+2xTR08+2xTR90+2xTR14 +TR1P+2xTR99+5xNL41

Dodatkowa dopłata					
Półka pod monitor x1	Półka pod monitor x 2				
376,-	752,-				
376,-	752,-				
376,-	752,-				

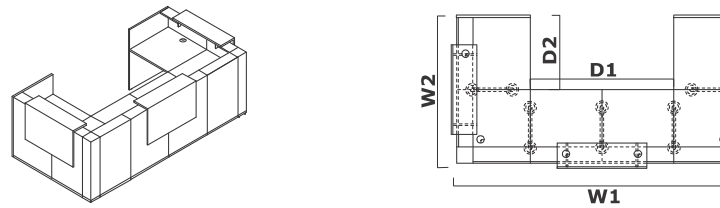

Symbol	Cena netto PLN	Wymiary					Waga Obj. Opak.	Elementy składowe
		W1	W2	D1	D2	H		
TRA129	14120,-	3354	1705			1159	304.2 kg 1.349 m ³ 18 szt.	TR1L+2xTR08+2xTR90+2xTR08 +TR1P+3xTR99+5xNL41
TRA130	14240,-	3754	1705			1159	312.6 kg 1.374 m ³ 18 szt.	TR1L+2xTR08+2xTR90+2xTR10 +TR1P+3xTR99+5xNL41
TRA131	14390,-	4154	1705			1159	329 kg 1.398 m ³ 18 szt.	TR1L+2xTR08+2xTR90+2xTR12 +TR1P+3xTR99+5xNL41
TRA132	14530,-	4554	1705			1159	345.9 kg 1.422 m ³ 18 szt.	TR1L+2xTR08+2xTR90+2xTR14 +TR1P+3xTR99+5xNL41

Dodatkowa dopłata					
Półka pod monitor x1	Półka pod monitor x 2				
376,-	752,-				
376,-	752,-				
376,-	752,-				

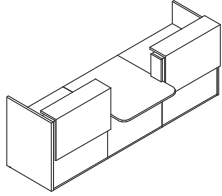
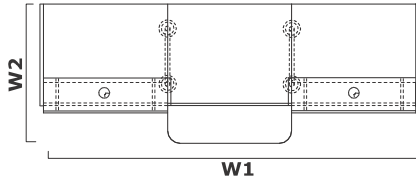
								
Symbol	Cena netto PLN	Wymiary					Waga Obj. Opak.	Elementy składowe
		W1	W2	D1	D2	H		
TRA33	6988,-	3056	1120			1159	177.15 kg 0.793 m3 11 szt.	TR1L+TR10+TR2P+TR11+TR2L +TR10+TR1P+2xTR99+2xNL41
TRA34	7138,-	3456	1120			1159	193.55 kg 0.817 m3 11 szt.	TR1L+TR12+TR2P+TR11+TR2L +TR12+TR1P+2xTR99+2xNL41
TRA35	7278,-	3856	1120			1159	210.45 kg 0.841 m3 11 szt.	TR1L+TR14+TR2P+TR11+TR2L +TR14+TR1P+2xTR99+2xNL41

Dodatkowa dopłata						
Półka pod monitor x1	Półka pod monitor x 2					
376,-	752,-					
376,-	752,-					
376,-	752,-					

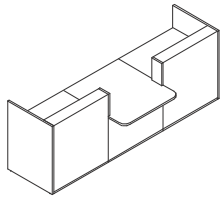
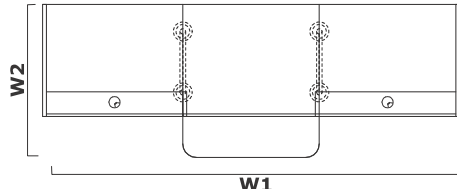
								
Symbol	Cena netto PLN	Wymiary					Waga Obj. Opak.	Elementy składowe
		W1	W2	D1	D2	H		
TRA133	3768,-	3056	1120			1090	143.15 kg 0.426 m3 9 szt.	TR1L+TR10+TR2P+TR11+TR2L +TR10+TR1P+2xNL41
TRA134	3918,-	3456	1120			1090	159.55 kg 0.451 m3 9 szt.	TR1L+TR12+TR2P+TR11+TR2L+TR12+TR1P+2xNL41
TRA135	4058,-	3856	1120			1090	176.45 kg 0.475 m3 9 szt.	TR1L+TR14+TR2P+TR11+TR2L+TR14+TR1P+2xNL41

Dodatkowa dopłata						
Półka pod monitor x1	Półka pod monitor x 2					
376,-	752,-					
376,-	752,-					
376,-	752,-					

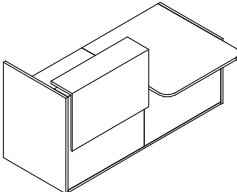

A

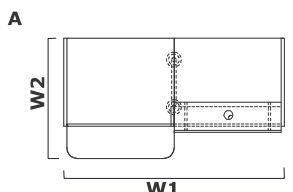

B

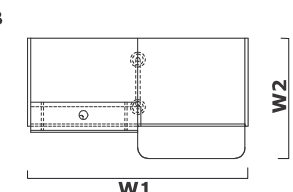

Symbol		Cena netto PLN	Wymiary					Waga Obj. Opak.	Elementy składowe
A	B		W1	W2	D1	D2	H		
TRA36L	TRA36P	4153,-	2056	1120			1159	118,4 kg 0,467 m ³ 7 szt.	A - TR1L+TR10+TR2P+TR11+TR3P +TR99+NL41 B - TR3L+TR11+TR2L+TR10+TR1P +TR99+NL41
TRA37L	TRA37P	4228,-	2256	1120			1159	126,6 kg 0,479 m ³ 7 szt.	A - TR1L+TR12+TR2P+TR11+TR3P +TR99+NL41 B - TR3L+TR11+TR2L+TR12+TR1P +TR99+NL41
TRA38L	TRA38P	4298,-	2456	1120			1159	155,3 kg 0,493 m ³ 8 szt.	A - TR1L+TR14+TR2P+TR11+TR3P +TR99+NL41 B - TR3L+TR11+TR2L+TR14+TR1P +TR99+NL41

Dodatkowa dopłata						
Półka pod monitor x1						
	376,-					
	376,-					

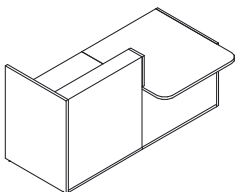

A

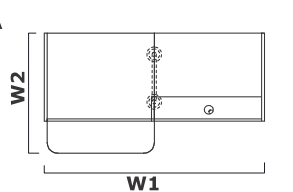

B

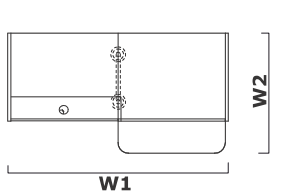

Symbol		Cena netto PLN	Wymiary					Waga Obj. Opak.	Elementy składowe
A	B		W1	W2	D1	D2	H		
TRA136L	TRA136P	2543,-	2056	1120			1090	101,4 kg 0,283 m ³ 6 szt.	A - TR1L+TR10+TR2P+TR11+TR3P +NL41 B - TR3L+TR11+TR2L+TR10+TR1P +NL41
TRA137L	TRA137P	2618,-	2256	1120			1090	109,6 kg 0,295 m ³ 6 szt.	A - TR1L+TR12+TR2P+TR11+TR3P +NL41 B - TR3L+TR11+TR2L+TR12+TR1P +NL41
TRA138L	TRA138P	2688,-	2456	1120			1090	118,05 kg 0,308 m ³ 6 szt.	A - TR1L+TR14+TR2P+TR11+TR3P +NL41 B - TR3L+TR11+TR2L+TR14+TR1P +NL41

Dodatkowa dopłata						
Półka pod monitor x1						
	376,-					
	376,-					

.mdd

Tera

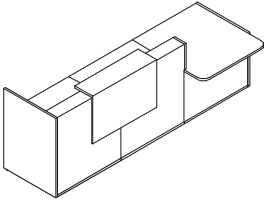
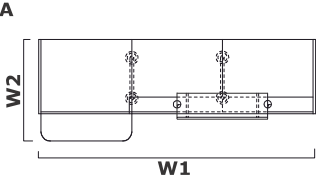
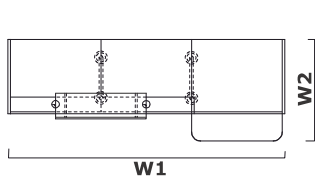
Symbol		Cena netto PLN	Wymiary					Waga Obj. Opak.	Elementy składowe
A	B		W1	W2	D1	D2	H		
TRA39L	TRA39P	5274,-	3056	1120			1159	152.4 kg 0.596 m3 9 szt.	A - TR1L+2xTR10+TR2P+TR11+TR3P+TR99+2xNL41 B - TR3L+TR11+TR2L+2xTR10+TR1P+TR99+2xNL41
TRA40L	TRA40P	5424,-	3456	1120			1159	168.8 kg 0.62 m3 9 szt.	A - TR1L+2xTR12+TR2P+TR11+TR3P+TR99+2xNL41 B - TR3L+TR11+TR2L+2xTR12+TR1P+TR99+2xNL41
TRA41L	TRA41P	5564,-	3856	1120			1159	185.7 kg 0.645 m3 9 szt.	A - TR1L+2xTR14+TR2P+TR11+TR3P+TR99+2xNL41 B - TR3L+TR11+TR2L+2xTR14+TR1P+TR99+2xNL41

Dodatkowa dopłata					
Półka pod monitor x1	Półka pod monitor x 2				
376,-	752,-				
376,-	752,-				
376,-	752,-				

Symbol		Cena netto PLN	Wymiary					Waga Obj. Opak.	Elementy składowe
A	B		W1	W2	D1	D2	H		
TRA43L	TRA43P	10406,-	3905	2348			1159	260.85 kg 1.083 m3 15 szt.	A - TR3P+TR11+TR2P+2xTR10+2xTR99+TR90+TR12+TR1L+4xNL41 B - TR1P+TR12+TR90+2xTR99+2xTR10+TR2L+TR11+TR3L+4xNL41
TRA44L	TRA44P	10556,-	4305	2348			1159	357.65 kg 1.264 m3 17 szt.	A - TR3P+TR11+TR2P+2xTR12+2xTR99+TR90+TR12+TR1L+4xNL41 B - TR1P+TR12+TR90+2xTR99+2xTR12+TR2L+TR11+TR3L+4xNL41
TRA45L	TRA45P	10696,-	4705	2348			1159	294.15 kg 1.131 m3 15 szt.	A - TR3P+TR11+TR2P+2xTR14+2xTR99+TR90+TR12+TR1L+4xNL41 B - TR1P+TR12+TR90+2xTR99+2xTR14+TR2L+TR11+TR3L+4xNL41

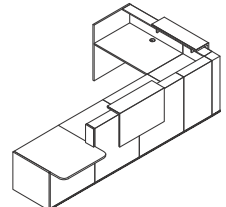
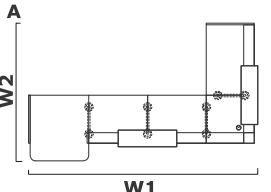
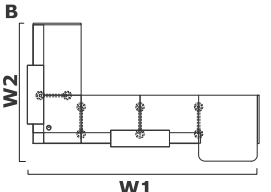
Dodatkowa dopłata					
Półka pod monitor x1	Półka pod monitor x 2				
376,-	752,-				
376,-	752,-				
376,-	752,-				

Elementy składowe							
	Symbol	Cena netto PLN	Wymiary			Waga Obj. Opak.	Uwagi
			Szer.	Gł.	Wys.		
	TR08	895,-	800	818	1090	27.8 kg 0,054 m3 1 szt.	
	TR10	955,-	1000	818	1090	32 kg 0,067 m3 1 szt.	
	TR12	1030,-	1200	818	1090	40.2 kg 0,079 m3 1 szt.	
	TR14	1100,-	1400	818	1090	48.65 kg 0,091 m3 1 szt.	
	TR90	2160,-	818	818	1090	47.25 kg 0,098 m3 2 szt.	element narożny
	TR11	790,-	1000	1120	740	33.95 kg 0,092 m3 1 szt.	
	TR18	695,-	800	1120	740	25.9 kg 0,07 m3 1 szt.	
	TR21	715,-	1000	820	740	32 kg 0,064 m3 1 szt.	
	TR28	625,-	800	820	740	23 kg 0,052 m3 1 szt.	
	TR99	1610,-	1000	282	650	17 kg 0,183 m3 1 szt.	nadstawka
	TR1L	280,-	28	820	1090	18.5 kg 0,035 m3 1 szt.	bok lady wysokiej - lewy
	TR1P	280,-	28	820	1090	19 kg 0,035 m3 1 szt.	bok lady wysokiej - prawy

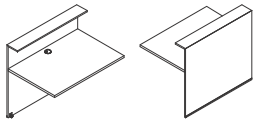
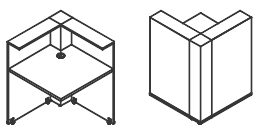
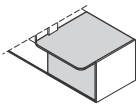
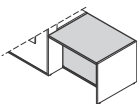
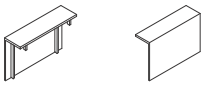
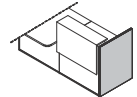
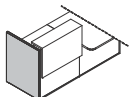
Dodatkowa dopłata							
Półka pod monitor x1							
	376,-						
	376,-						
	376,-						

